

TE



FIXED VERSION

Fixed multi-purpose medium shredder for tractors from 35 to 70 HP with widths from 145 to 220 cm, ideal for both the vineyard or orchard and for the open field.

Double working position:
centred or offset (320 mm)

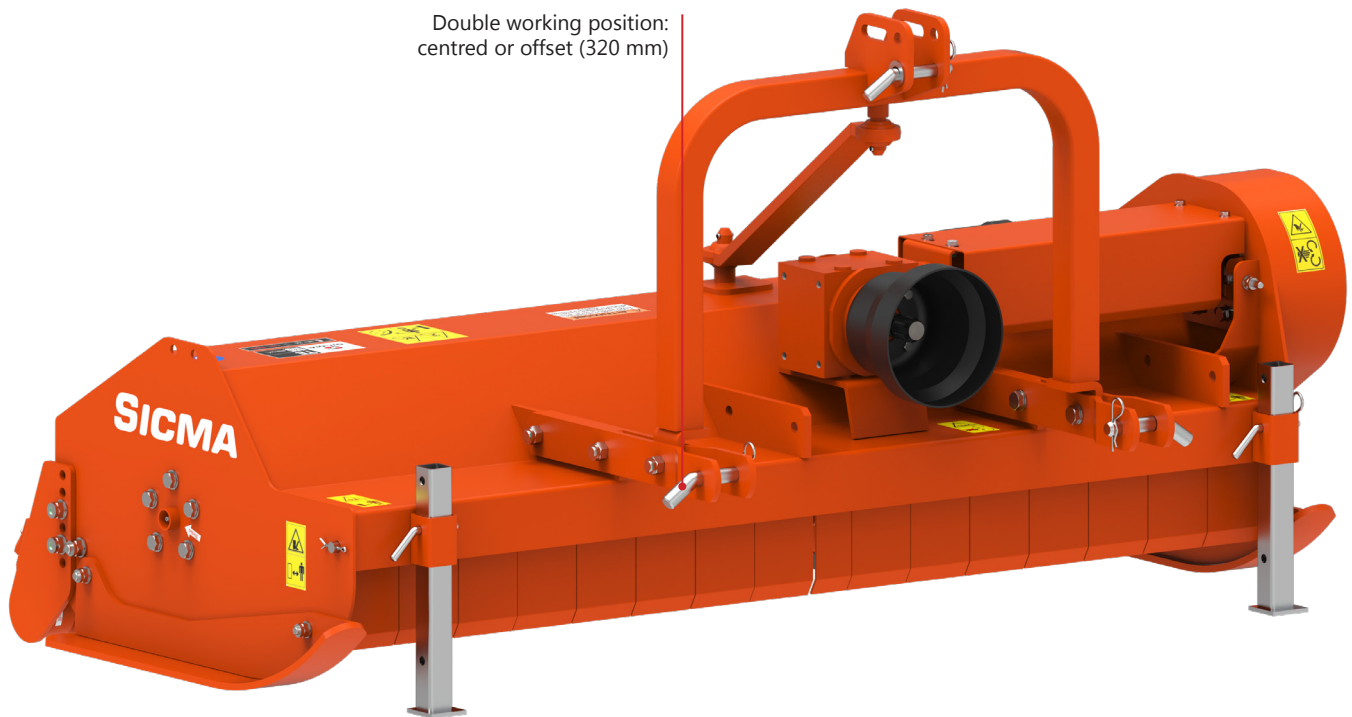





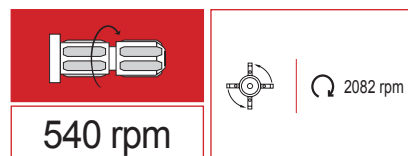



TECHNICAL DATA

Reducer speed:



Models and Features:

	 HP	 mm (in)	 mm (in)	 mm (in)	 kg (lbs)	 nr.	 nr.	 nr.	 cat.
TE 145	35 ▶ 70	1450 (57")	1580 (63")	300 (12")	332 (730)	36	18	3	1
TE 160	35 ▶ 70	1600 (63")	1780 (70")	300 (12")	362 (796)	40	20	3	1
TE 180	35 ▶ 70	1800 (80")	1980 (77")	300 (12")	392 (862)	44	22	3	1
TE 200	35 ▶ 70	2000 (81")	2180 (87")	300 (12")	432 (950)	52	26	4	1
TE 220	35 ▶ 70	2200 (87")	2380 (94")	300 (12")	452 (994)	56	28	4	1



Universal shaft
(Eurocardan) size 5



Gearbox made by SICMA, with tapered roller bearings, integrated freewheel, caps for oil input and discharge and level cap with sight glass

Rear hooks in hammer version

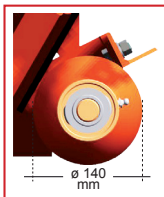
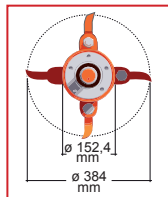

Rear stabiliser roller bearings shielded and protected from contact with external agents (soil, grass, pruning waste)

Counterblade system in cutting chamber

Object launch protection blades

Transmission with V-belts and manual belt tensioner system

Rotor supports with high reliability bearings equipped with NILOS lubricant seals

High resistance self-centring pulley shrink discs

Helical shaft

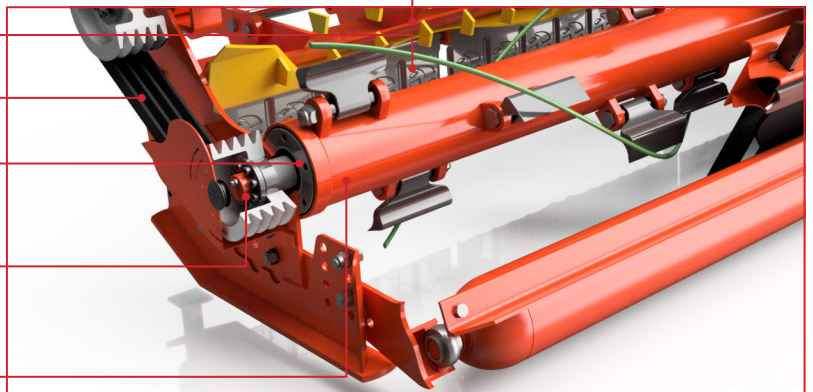

ACCESSORIES



Rubber swivelling wheel to replace roller

Ideal for stony soils and does not compact the ground like a roller.

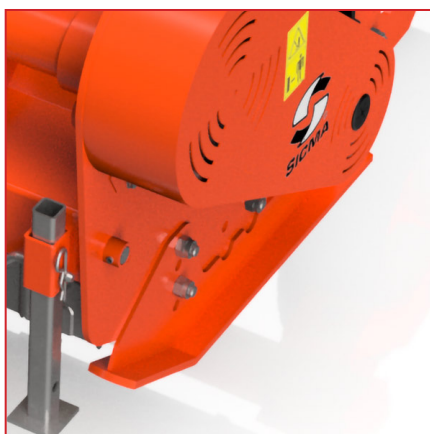

Side skids

They allow the adjustment of the working height.



Hydraulic cylinder for shifting

It is used to move the flail mower sideways with a jack without getting off the tractor



SICMA

*The experience that cultivates
the future of your land*

SICMA S.p.a. is an Italian company and a leader in
the professional agricultural machinery sector.
We design and create cutting-edge solutions for
you, the farmer of tomorrow. Innovation and
passion at your service.



MIGLIANICO | ABRUZZO | ITALY

Sicma SpA

Contrada Cerreto, 39
66010 Miglianico (CH)
Tel. +39 0871 95841

info@sicma.it - www.sicma.it

